

SBL /SBLF SERIES

Indoor LED Backlit Sign Installation Instructions



Voltage

This sign operates within an input range of 120VAC to 277VAC.

What You Need:

- Phillips Head Screw Driver
- Control Switch (*ordered separately*)
- Appropriate Wall Fasteners
- Wire Connectors
- Pencil
- Level

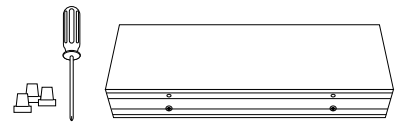

Always turn off the power prior to installation.



Be sure any metal debris cleared out of the cabinet.

Installation of Single and Double Faced Cabinets

2½" and 2¼" Deep Single Sided - w/ Integrated Wall Mount

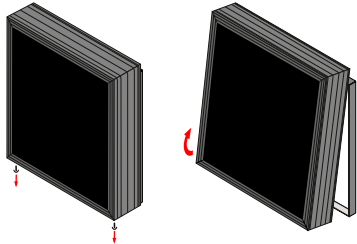

1. Remove the two screws on the bottom of the front frame of the cabinet.
2. Lift cabinet open. **Note:** Cabinet can be removed from backing plate for easy wall mounting. See Below.
3. All conduit connections **MUST** be water tight and preferably on the bottom of the cabinet. Any metal debris **MUST** be cleared out of the cabinet.
4. Make wiring connections following wiring instructions on the other side of this page.
5. To close, rest cabinet on lip of back plate and hinge closed. Replace the two screws removed in step 1.



Be sure any metal debris cleared out of the cabinet.

5½" Deep Single Sided

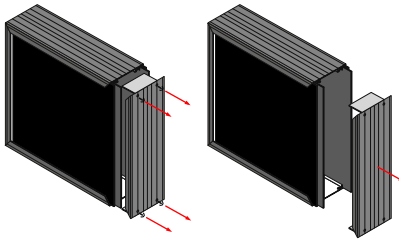

1. Remove the four screws on either the left or right side of the cabinet, but **NEVER** both.
2. Carefully remove the frame side, two corner keys will come out with the frame side. Be aware that the sign may temporarily lose some structural rigidity after removing the frame side depending on size.
3. All conduit connections **MUST** be water tight and preferably on the bottom of the cabinet. Any metal debris **MUST** be cleared out of the cabinet.
4. Make wiring connections, following wiring instructions on the other side of this page, by sliding the circuit boards out to wire them. Do **NOT** remove the face panels at the same time!
5. To close, reverse the steps, sliding circuit boards back in place and reattaching the frame side. Replace the four screws removed in step 1. **Note:** Individual boards **MUST** slide in extrusion slots to close properly!



Be sure any metal debris cleared out of the cabinet.

5½" Deep Single Sided Hinged Face

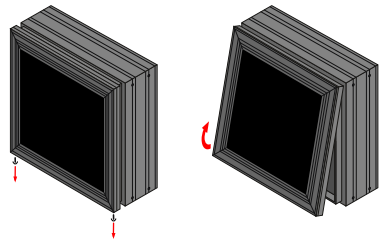

1. Remove the two screws on the bottom of the front frame of the cabinet.
2. Lift front face of cabinet open.
3. All conduit connections **MUST** be water tight and preferably on the bottom of the cabinet. Any metal debris **MUST** be cleared out of the cabinet.
4. Make wiring connections following wiring instructions on the other side of this page.
5. To close, reverse the steps, careful not to pinch any wiring in the frame sides while closing the front face. Replace the two screws removed in step 1.



Be sure any metal debris cleared out of the cabinet.

7½" Deep Double Sided Hinged Face

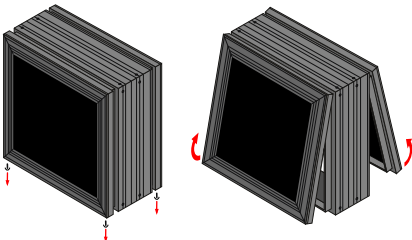

1. Remove the two screws on the bottom of the front and back frames of the cabinet.
2. Lift each face of cabinet open.
3. All conduit connections **MUST** be water tight and preferably on the bottom of the cabinet. Any metal debris **MUST** be cleared out of the cabinet.
4. Make wiring connections following wiring instructions on the other side of this page.
5. To close, reverse the steps, careful not to pinch any wiring in the frame sides while closing the front and back faces. Replace the two screws removed in step 1 on each face.



Be sure any metal debris cleared out of the cabinet.

Integrated Wall Mount Installation

All dimensions measured from the edge of the cabinet

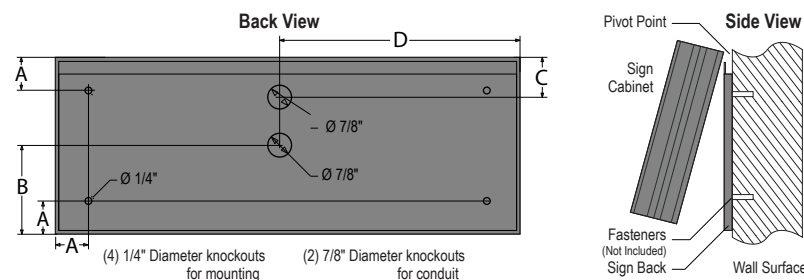

Cabinet High x Wide (Inches)	Dimension A Mounting Holes Vertical & Horizontal	Dimension B Center 7/8" Knock-out Vertical	Dimension C Top 7/8" Knock-out Vertical	Dimension D Center Knock-outs Horizontal
H x W	1¼"	Half of Sign Height	1¼"	Half of Sign Width

Making your Wiring Connections

1. To make your electrical connections easier, gently unplug the supplied wired pigtail connector from the power supply.

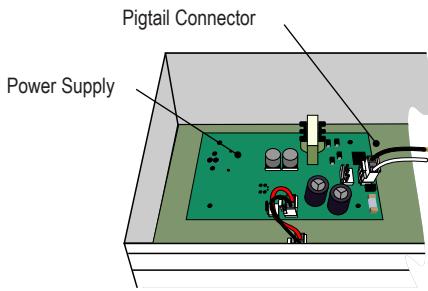

(Actual wire count varies by number of messages)

Pigtail Connector removed

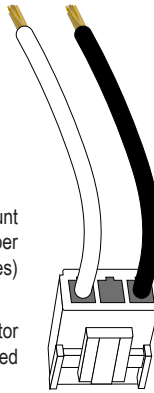

2. With your incoming power already running through the mounted back you can easily make all connections to the pigtail using wire connectors. (See table below for general wiring guidelines)
3. Plug the pigtail connector back into the power supply to finish off the electrical part of your installation. The connector is "keyed" and can only be installed in one orientation
4. You're done with the electrical! Time to close up the sign by pushing the cabinet closed and replacing the two screws you removed from the bottom of the cabinet.



Note: Make appropriate wiring connections per local code.

Sample Wiring Label

Wiring Label Sample for a typical 2 Message OPEN | CLOSED Sign

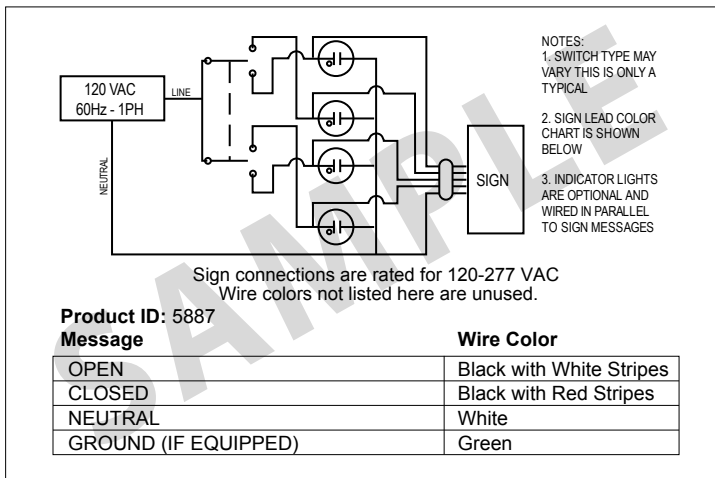

Note: Refer to the wiring label inside the sign for the specific instructions on wiring your sign. Some wires may not be used.

General Wiring Guidelines*

Typical Wire (Lead) Colors

Black with White Stripes

Black with Yellow Stripes

Black with Red Stripes

Black with Blue Stripes

Black with Gray Stripes

Black with Orange Stripes

Black with Purple Stripes

Black with Green Stripes

Black with Brown Stripes

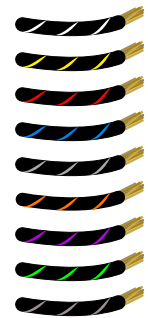

*Neutral is solid White and Ground (if equipped) is solid Green.



Note: Make appropriate wiring connections per local code.

Note: Any holes drilled into sign cabinet MUST be sealed. Failure to do so may cause a short and void warranty.

Note: This sign is intended to be installed in accordance with the requirements of Article 600 of the National Electric Code and/or other applicable local codes. This includes proper grounding and bonding of the sign.

Note: This unit contains a built-in CLASS 2 LED driver.

WARNING - Risk of Fire or Electric Shock. Do Not interconnect output terminations.

AVERTISSEMENT - Risque d'incendie ou de choc électrique. Ne pas interconnecter les terminaisons de sortie.

Normal Operation

There is one (1) LED on the power supply located close to the connector with the Red and Black wires. This LED marked V OUT, will illuminate green when 120 - 277VAC power is applied to the Pigtail.

Check the LED on each power supply since there may be more than one power supply per message.



Note: Transformer on power supply converts 120 - 277VAC to 12V.

